

G-POL-60/92

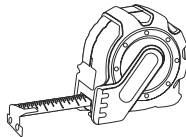

ϕ 5 mm
 ϕ 10 mm

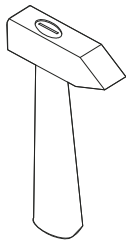
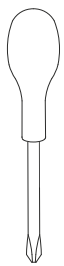
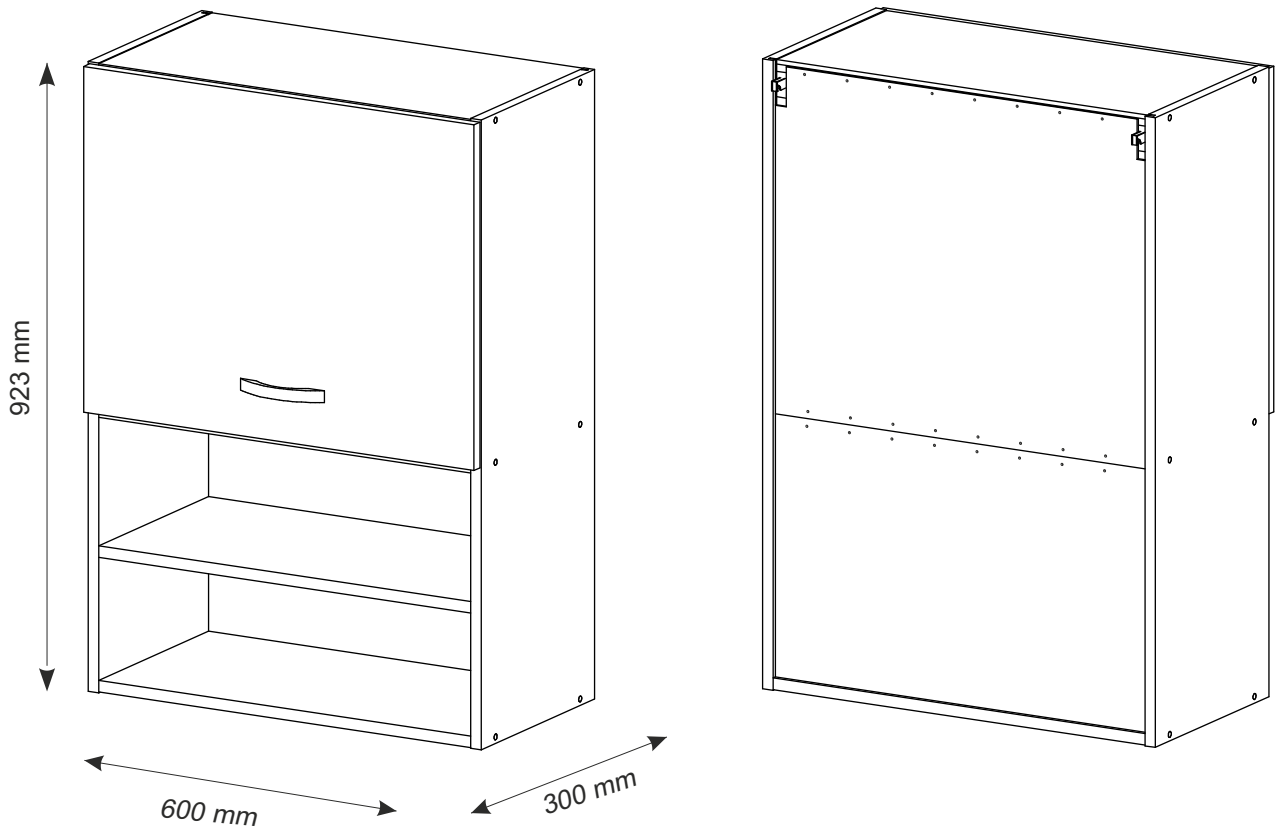
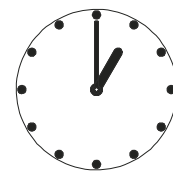
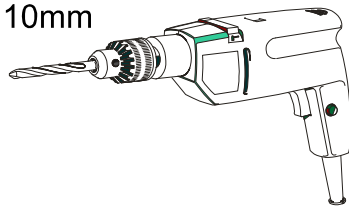

30 min

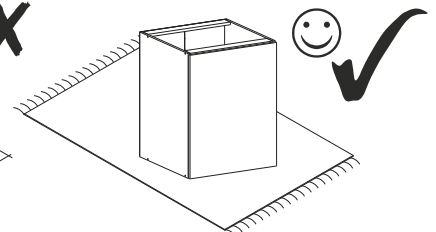
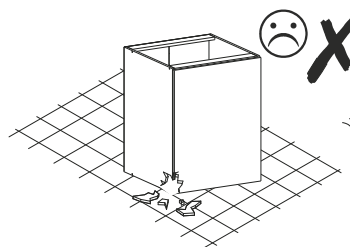
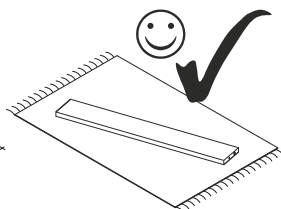
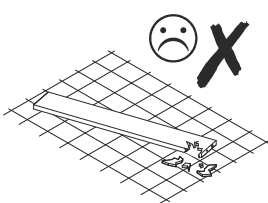
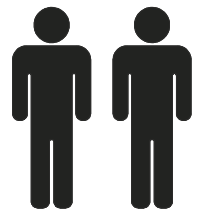

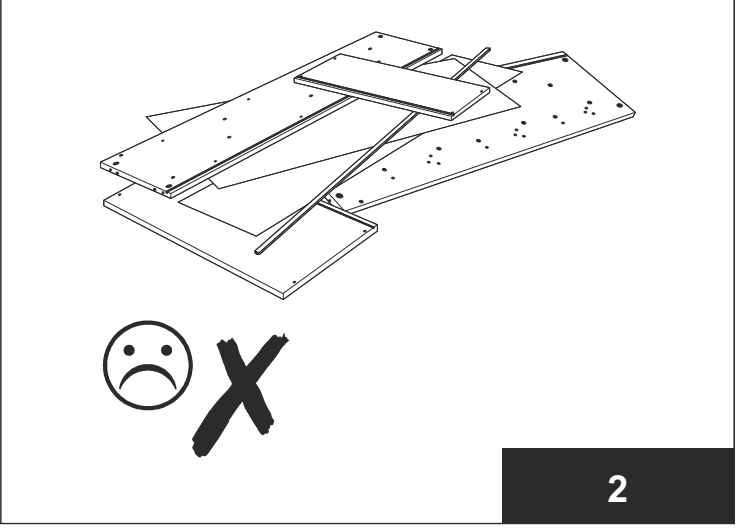
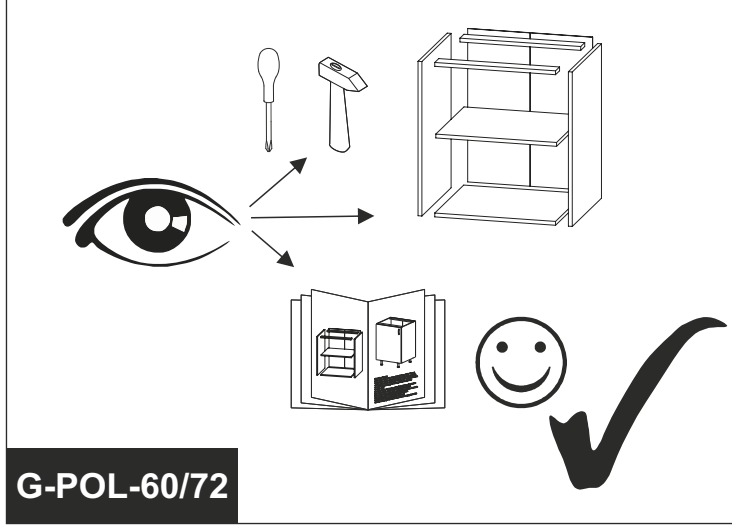
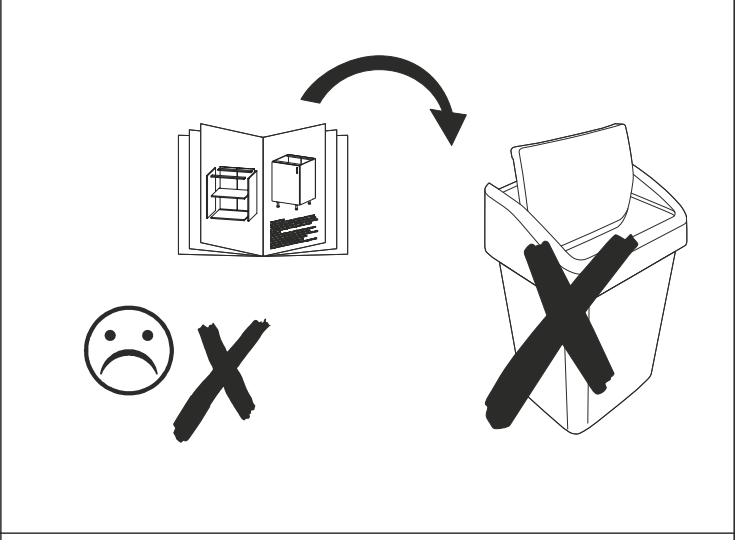
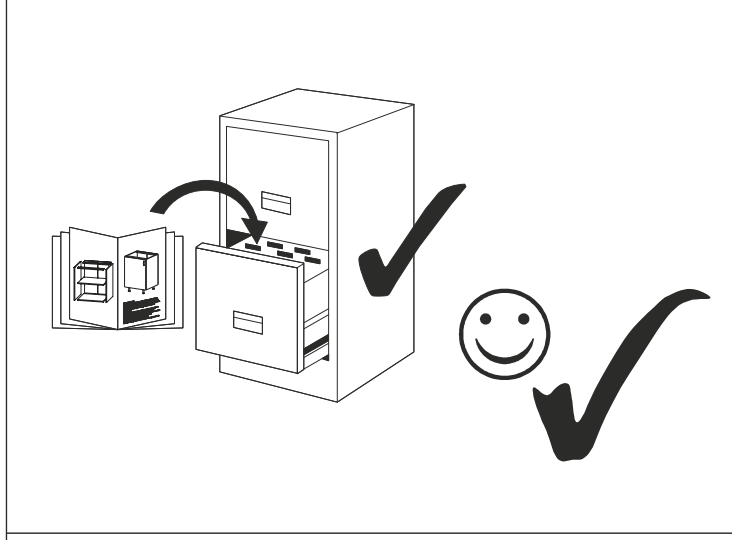
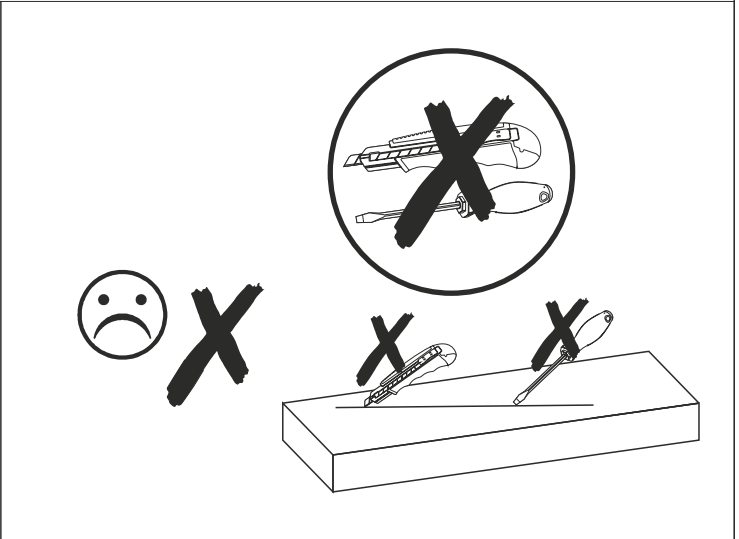
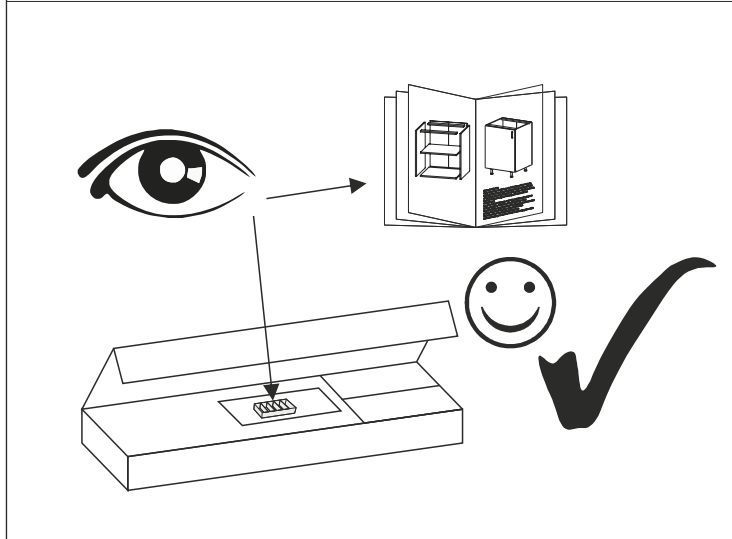

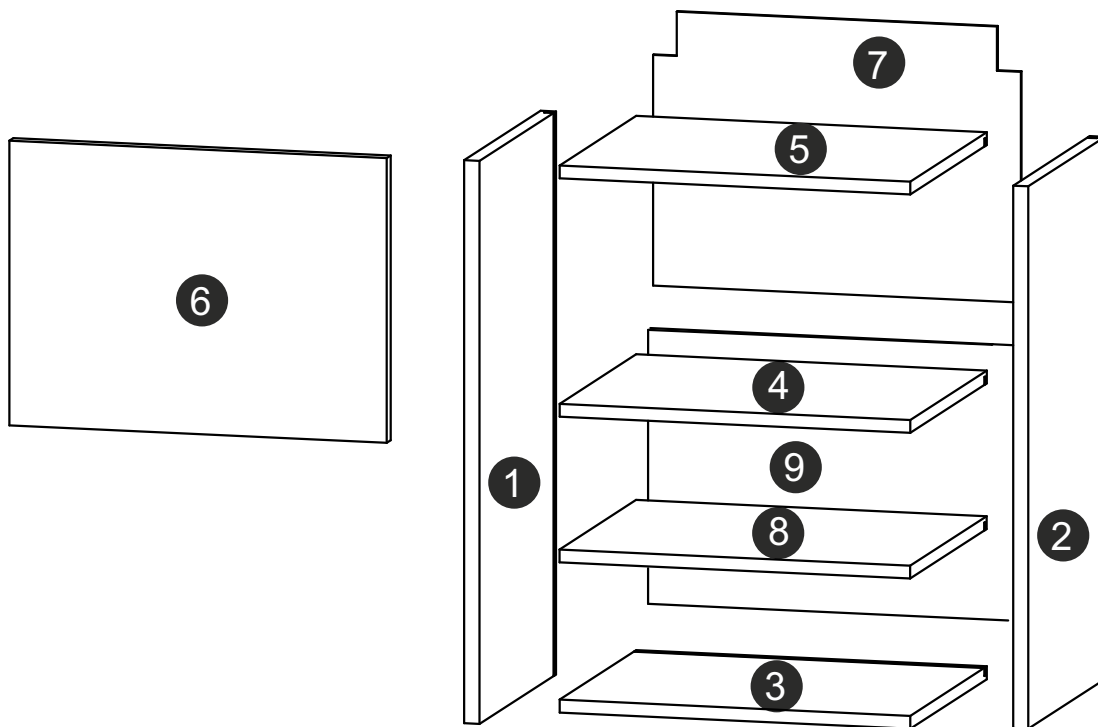

| | DŁUGOŚĆ | SZEROKOŚĆ | GRUBOŚĆ | ILOŚĆ | KOD | PACZKA |
|---|---------|-----------|---------|-------|-----|--------|
| 1 | 716 | 300 | 18 | 1 | | |
| 2 | 716 | 300 | 18 | 1 | | |
| 3 | 563 | 299 | 18 | 1 | | |
| 4 | 563 | 279 | 18 | 1 | | |
| 5 | 563 | 279 | 18 | 1 | | |
| 6 | 330 | 596 | 18 | 1 | | |
| 7 | 335 | 581 | 3 | 1 | | |
| 8 | 563 | 270 | 18 | 1 | | |
| 9 | 378 | 581 | 3 | 1 | | |

