

# GNWU-72

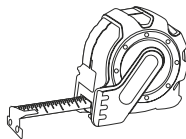

$\phi$  5 mm  
 $\phi$  10mm

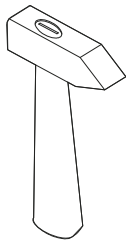
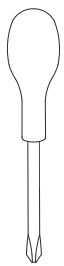
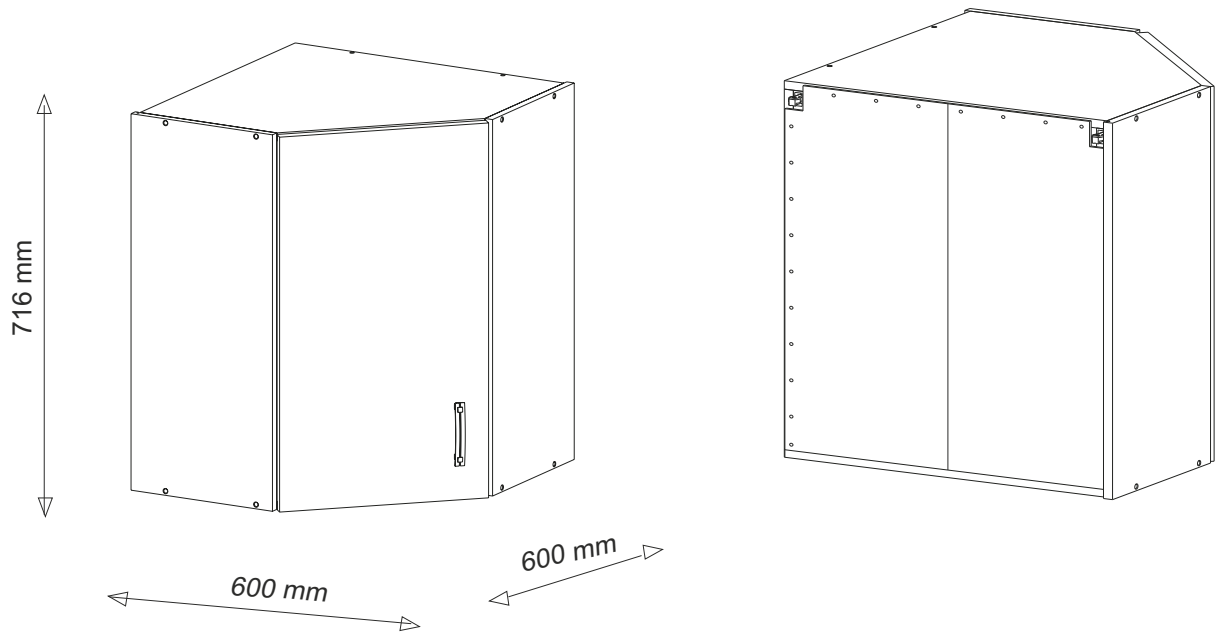
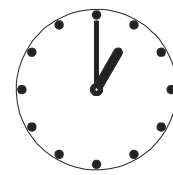
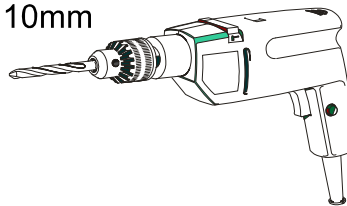

30 min

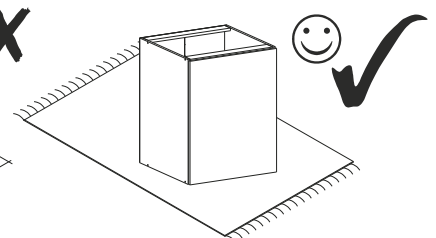
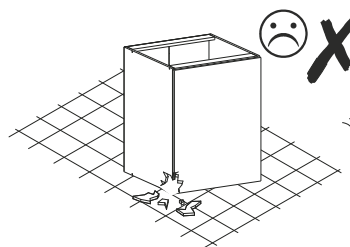
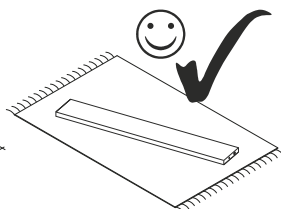
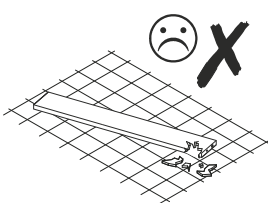
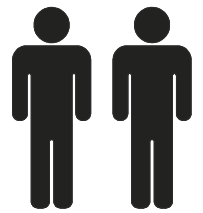

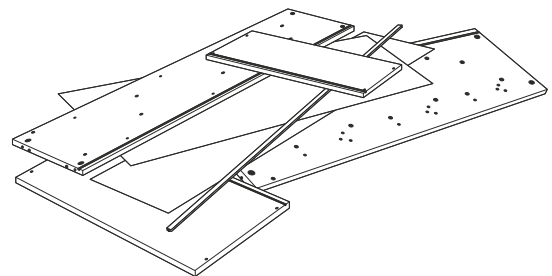
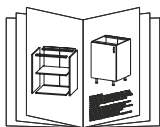
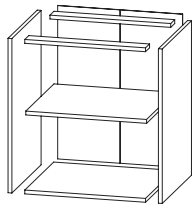
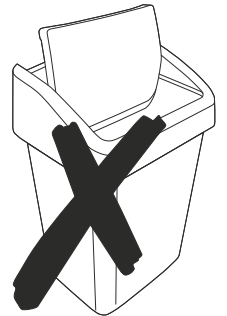
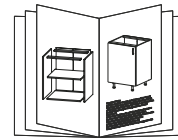
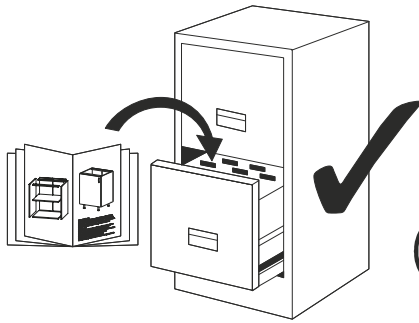
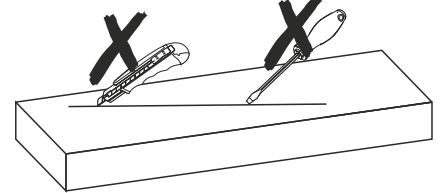
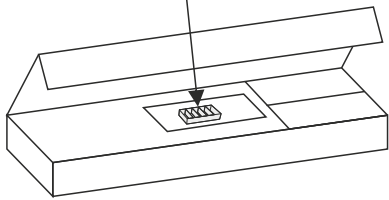
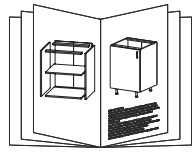

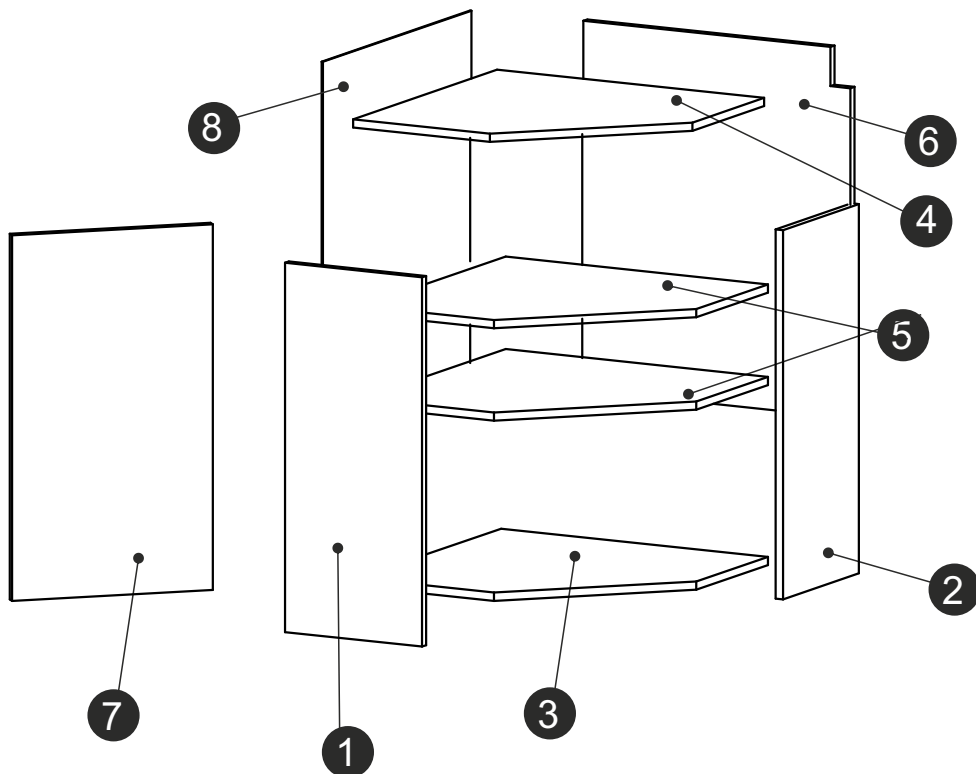

	DEUGOCÉ/Æ	SZEROKOCÉ/Æ	GRUBOCÉ/Æ	ILOCE/Æ	KOD	PACZKA
1	716	300	18	1		
2	716	300	18	1		
3	580	580	18	1		
4	560	560	18	1		
5	560	542	18	2		
6	679	560	18	1		
7	713	396	18	1		
8	703	565	3	1		

