

GO-45-GL56

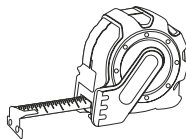

ϕ 5 mm
 ϕ 10 mm

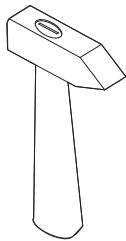
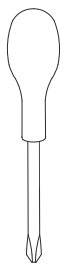
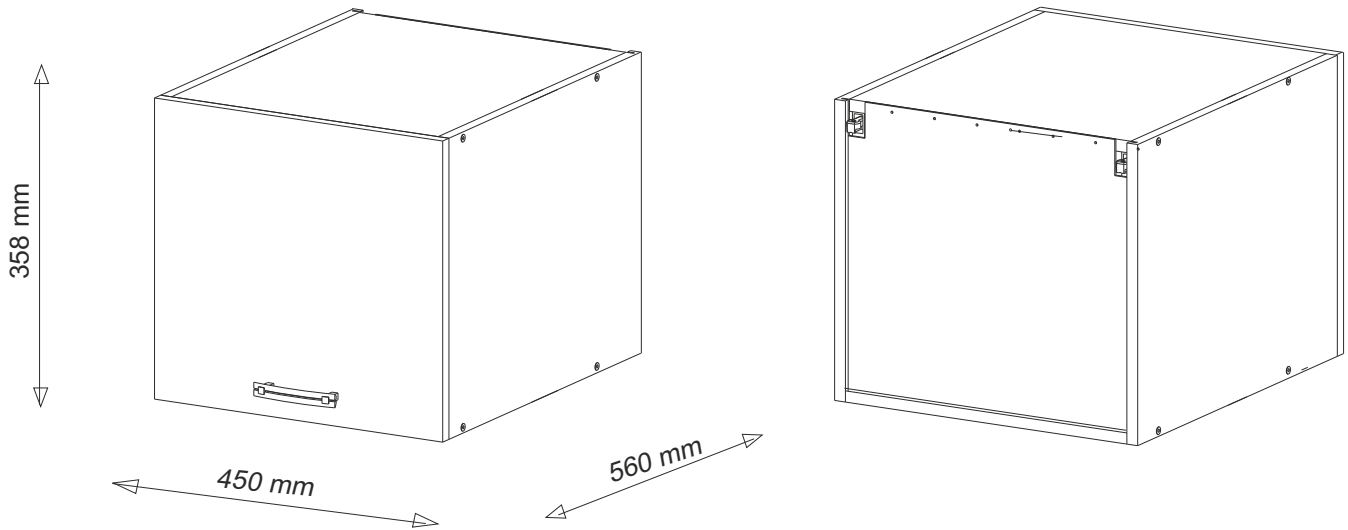
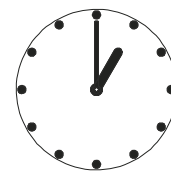
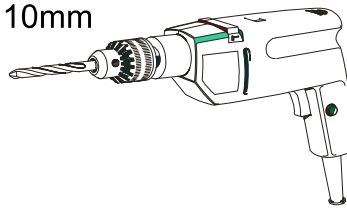

30 min

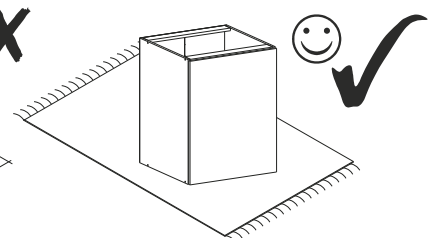
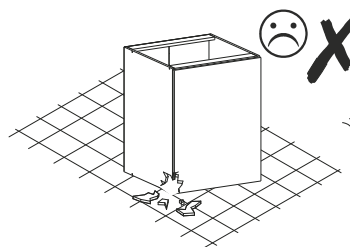
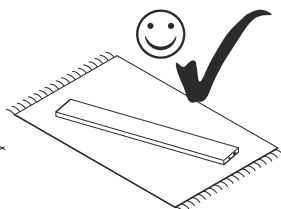
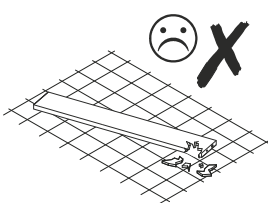
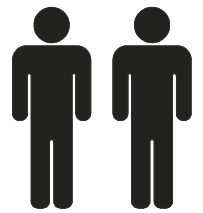

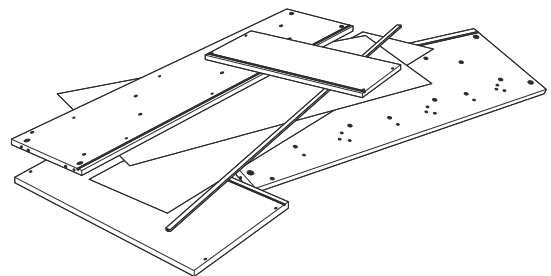
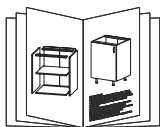
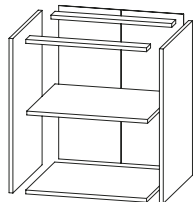
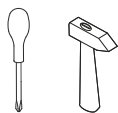
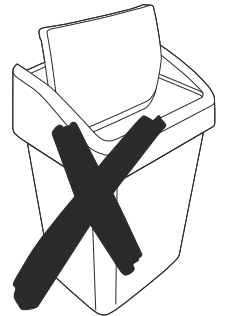
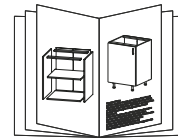
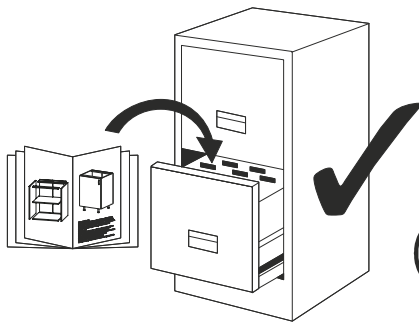
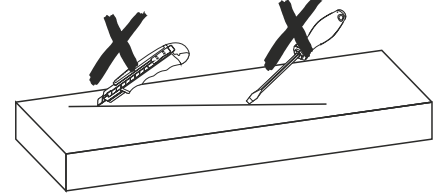
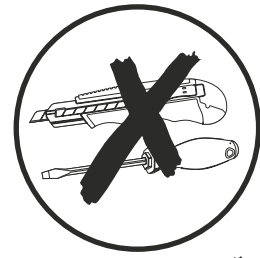
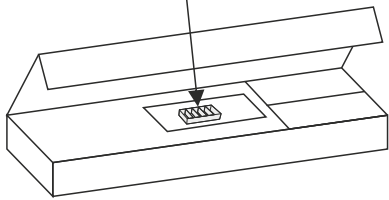
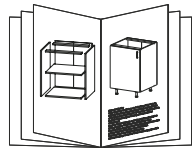

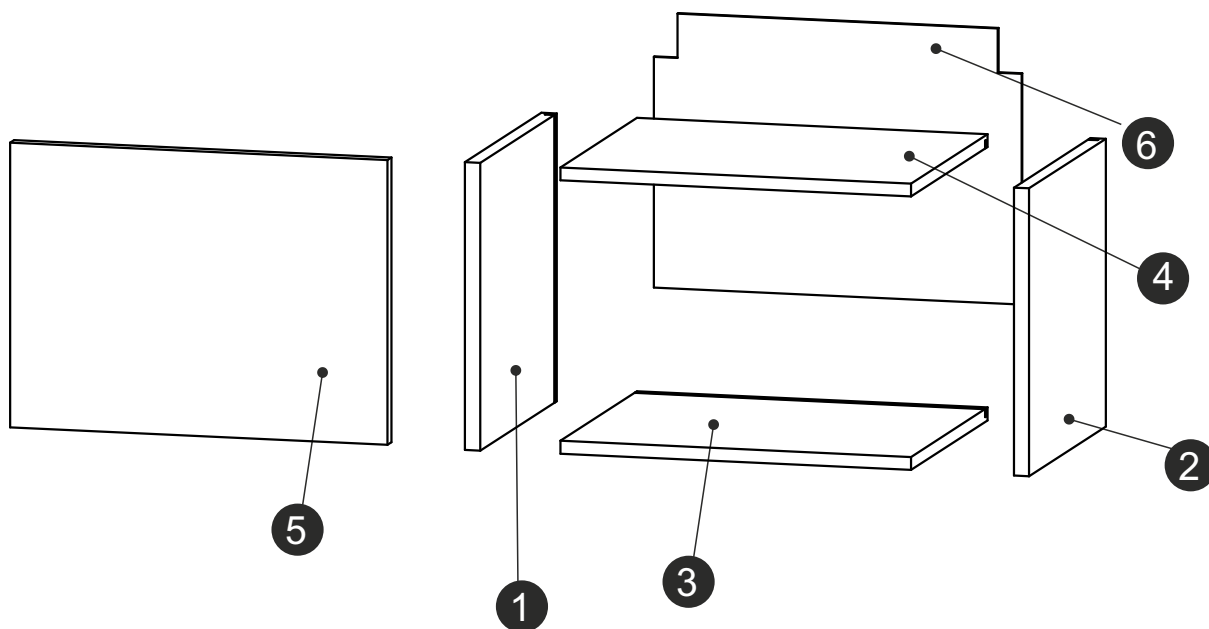

	DŁUGOŚĆ LENGTH LONGEUR	SZEROKOŚĆ WIDTH LARGEUR	GRUBOŚĆ THICKNESS STÄRKE GROSSEUR	ILOŚĆ QUANTITY ANZAHL QUANTITÉ	KOD CODE CODE CODE	PACZKA BOX SCHACHTEL BOÎTE
1	358	560	18	1		
2	358	560	18	1		
3	413	559	18	1		
4	413	539	18	1		
5	355	446	18	1		
6	345	431	3	1		

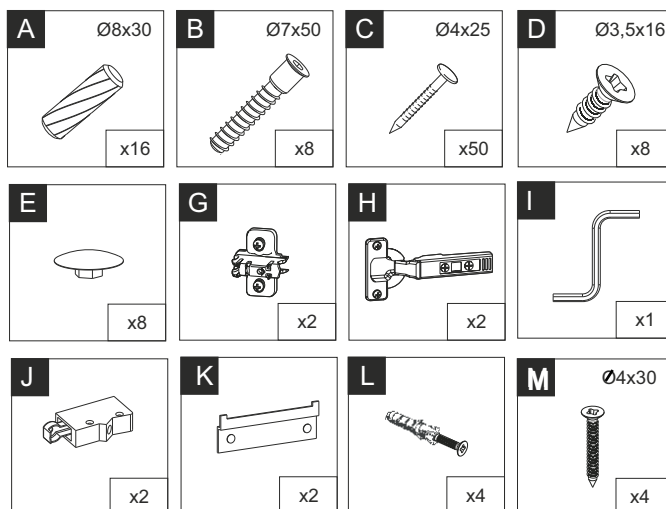

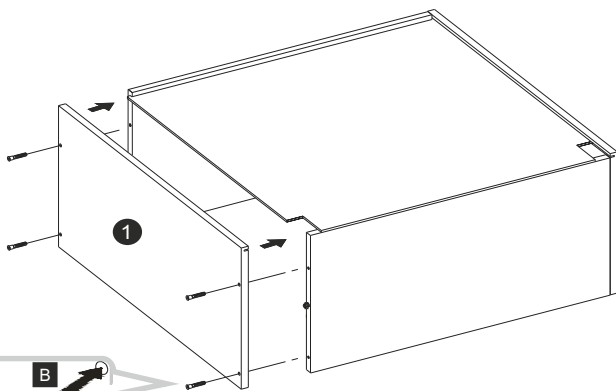
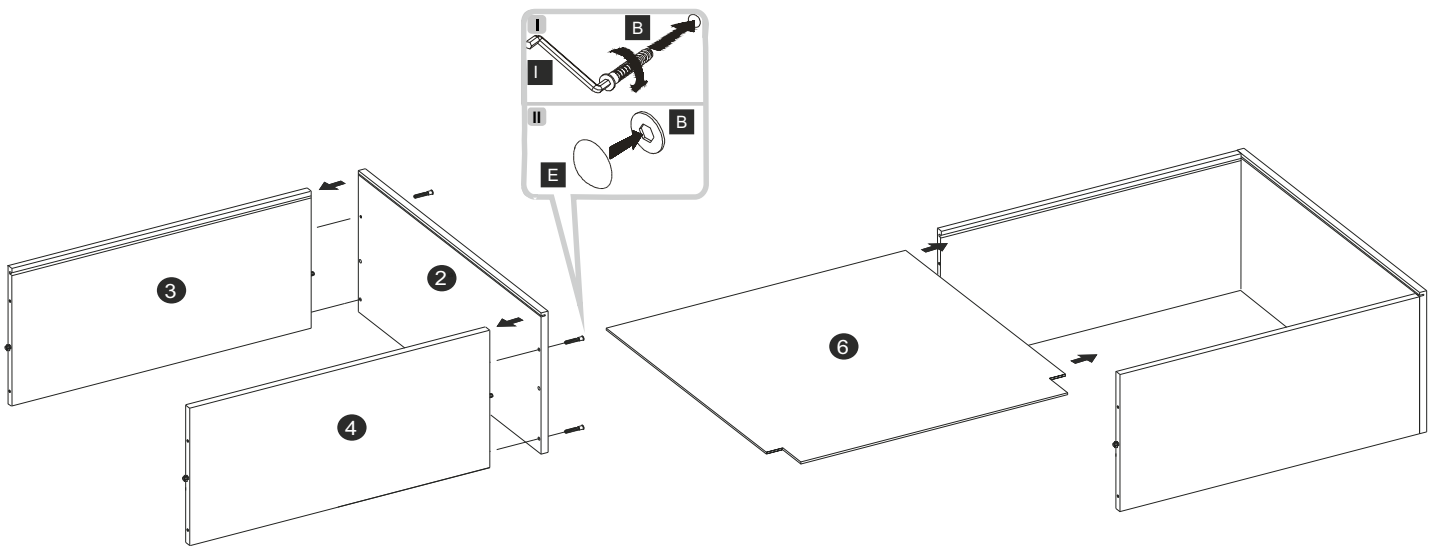
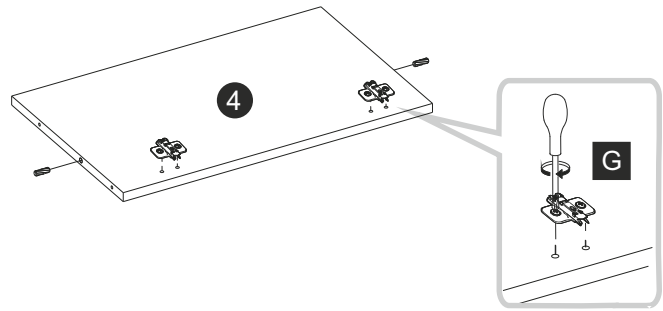
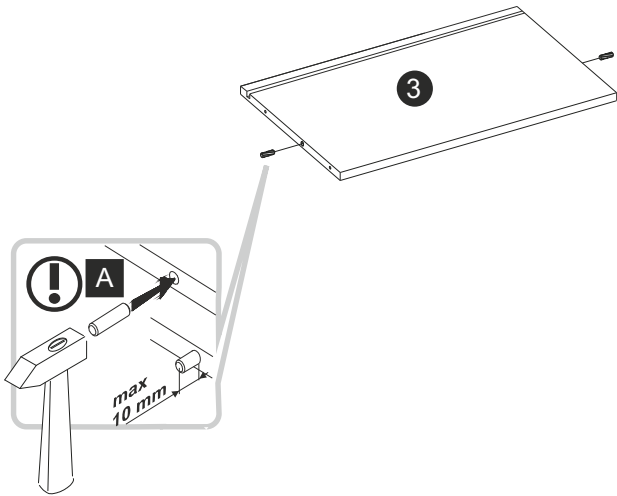

! a=b

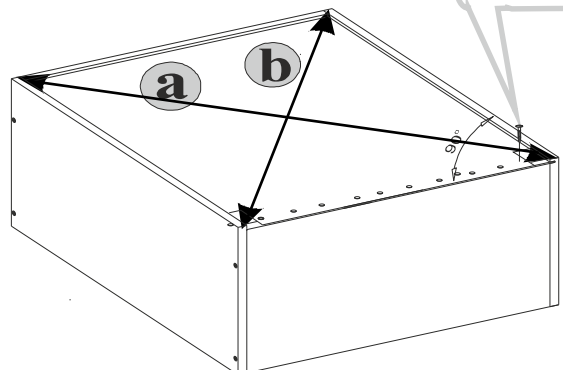
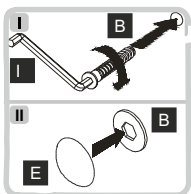
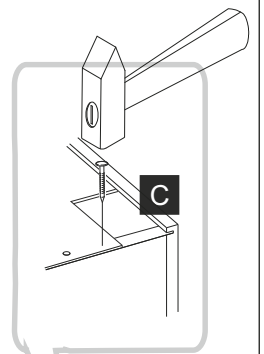

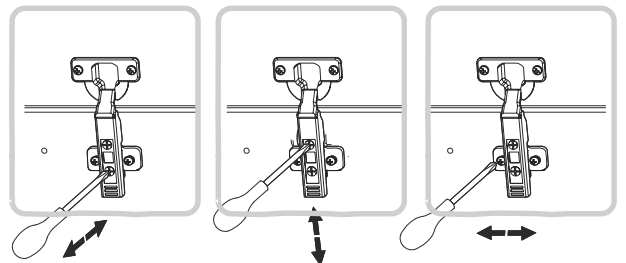
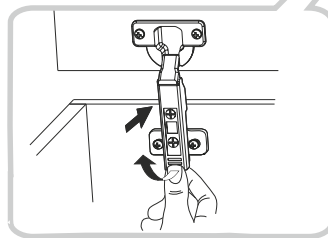
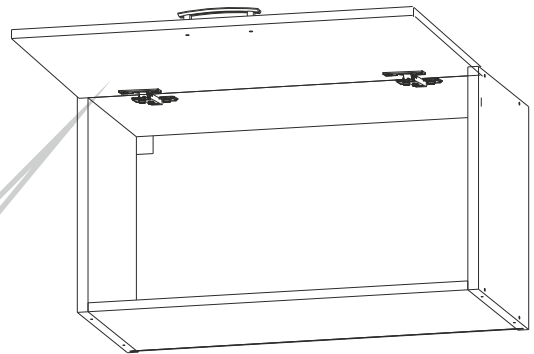
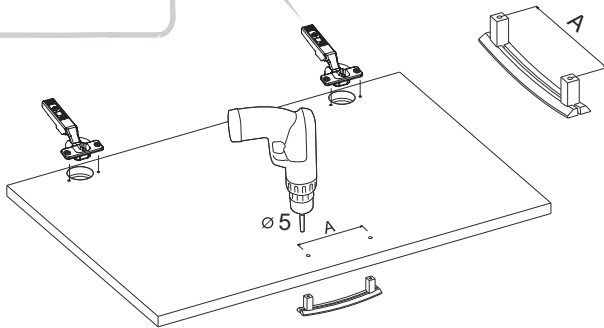
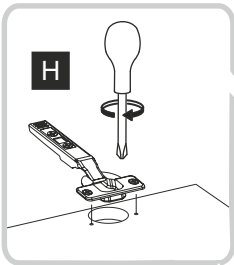
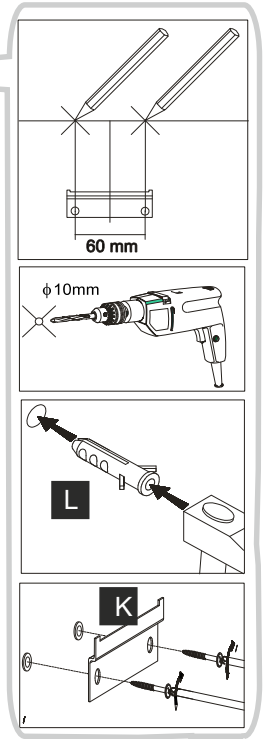
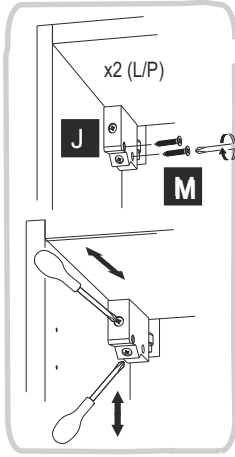
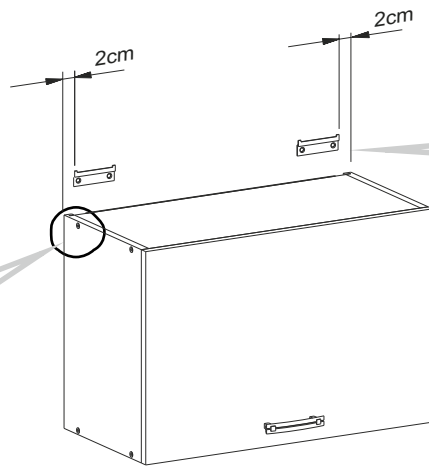
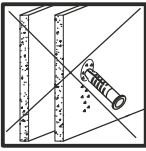
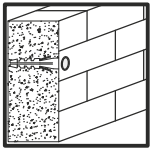

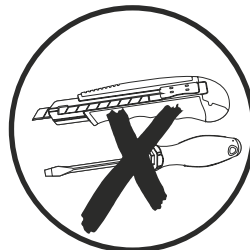
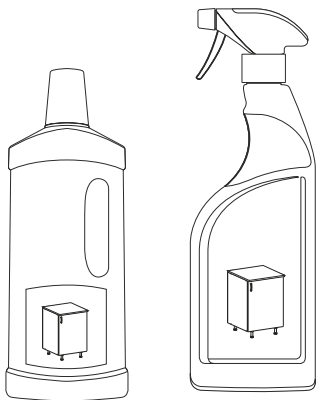
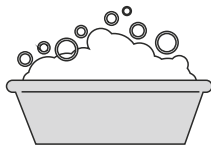
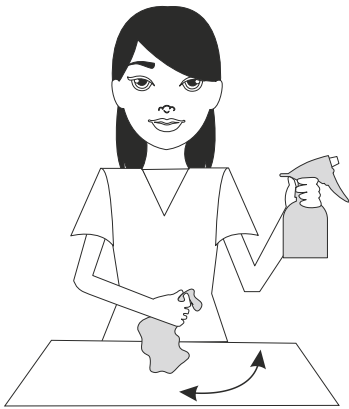
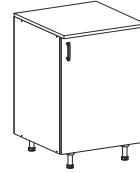
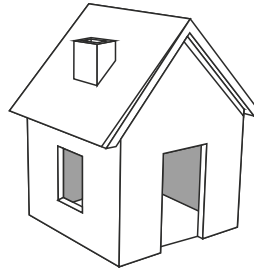
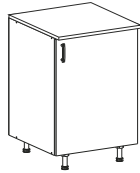
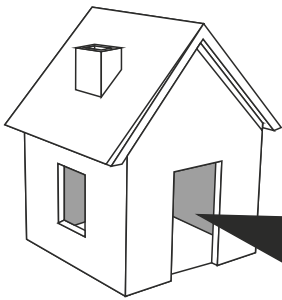

PODNOŚNIK GAZOWY

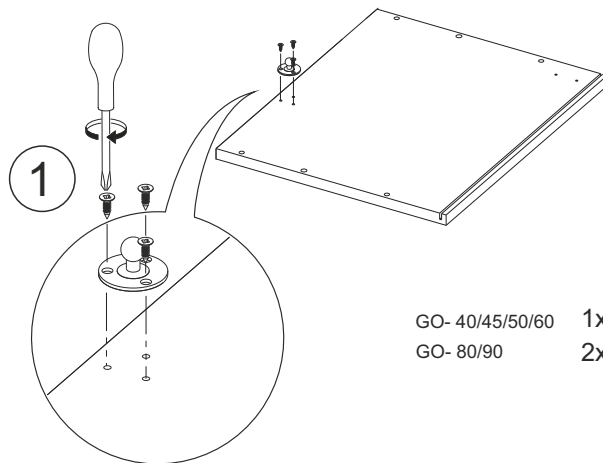
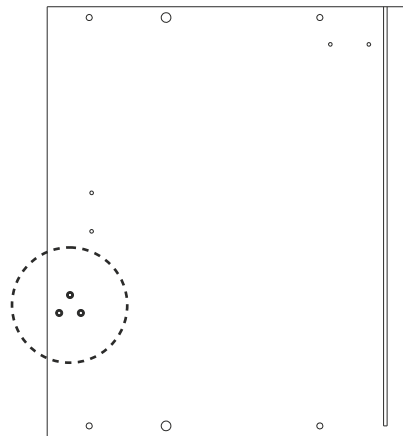
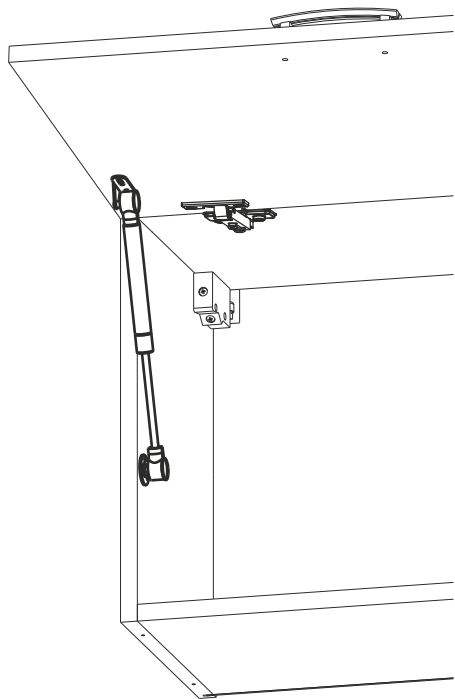



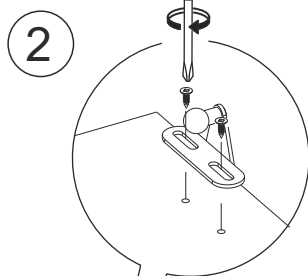
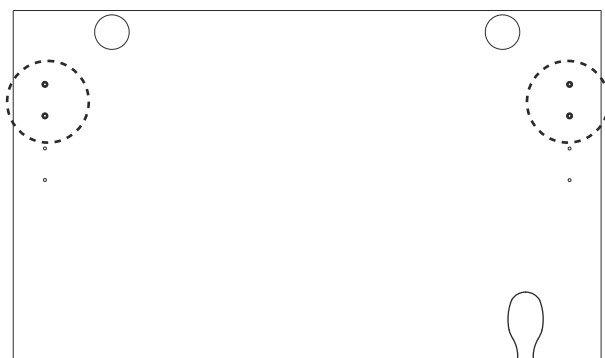

GO- 40/45/50/60 1x
GO- 80/90 2x (L/P)

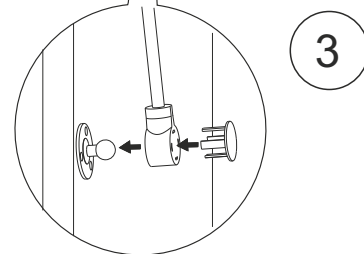
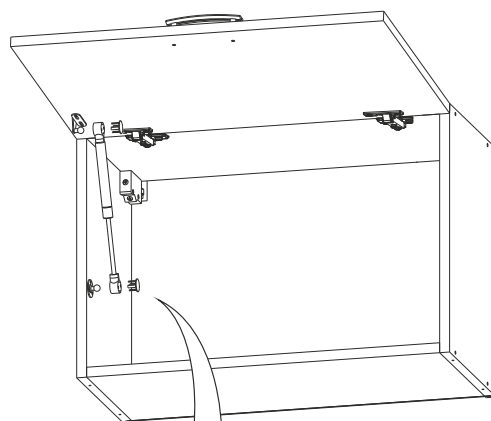
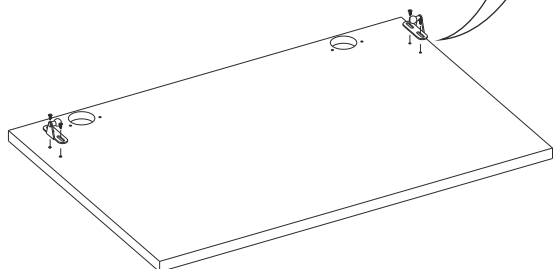

GO- 40/45/50/60 1x
GO- 80/90 2x (L/P)



GO- 40/45/50/60	1x	1x	2x	5x
GO- 80/90	2x	2x	4x	10x
				

GO- 40/45/50/60 1x
GO- 80/90 2x



PODNOŠENIK HK XS

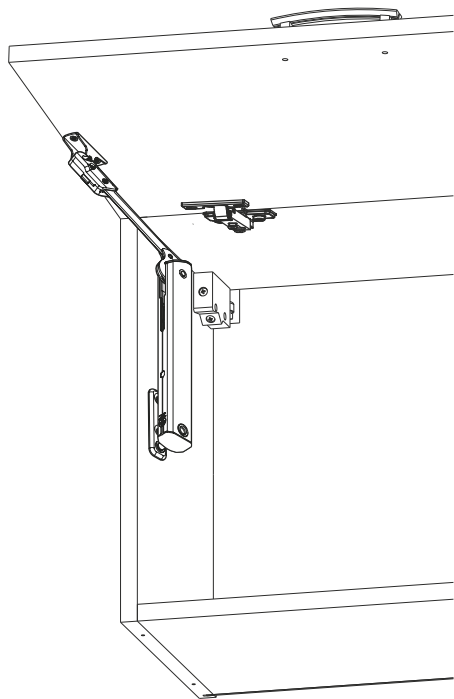

1

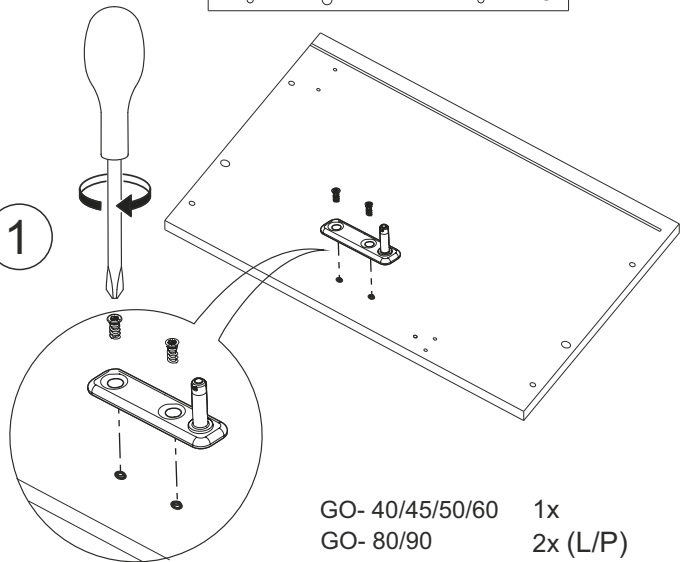

GO- 40/45/50/60 1x
GO- 80/90 2x (L/P)

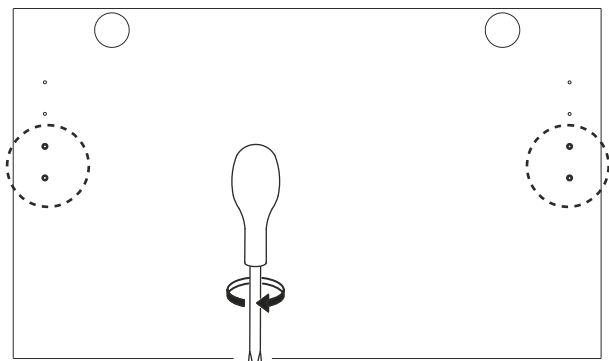

2

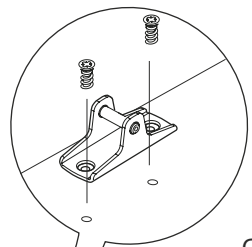

GO- 40/45/50/60 1x
GO- 80/90 2x (L/P)

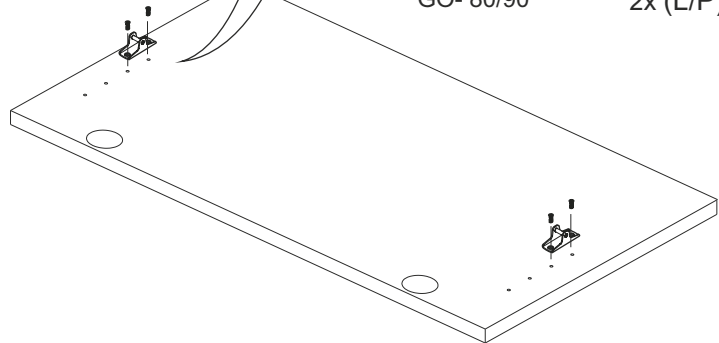

3

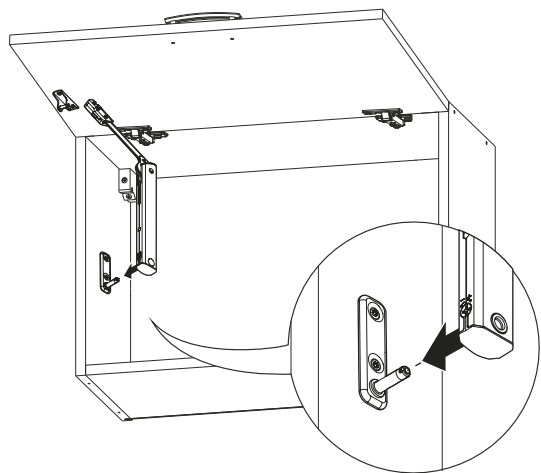

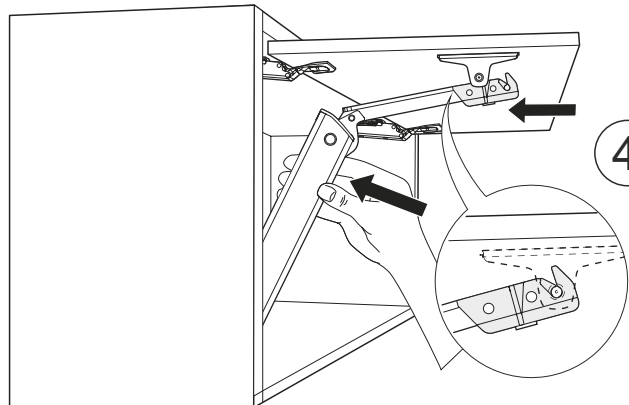

4

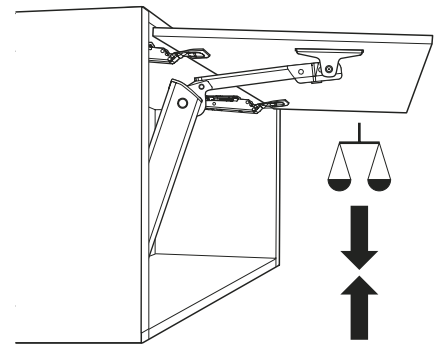
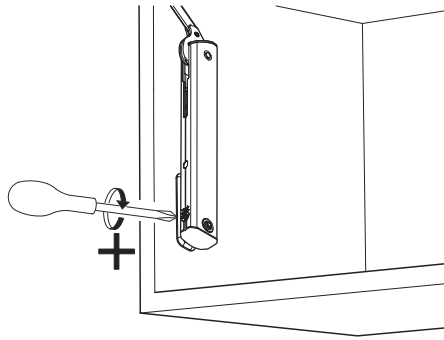
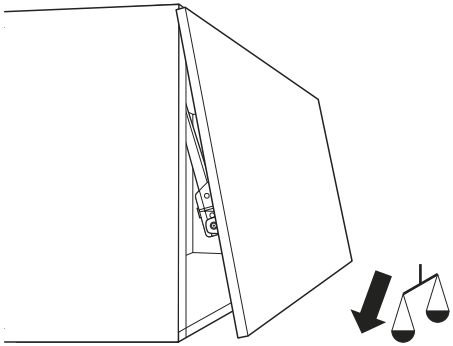
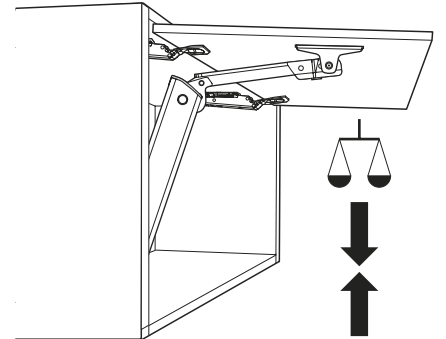
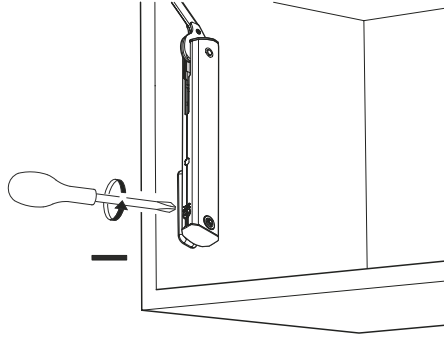
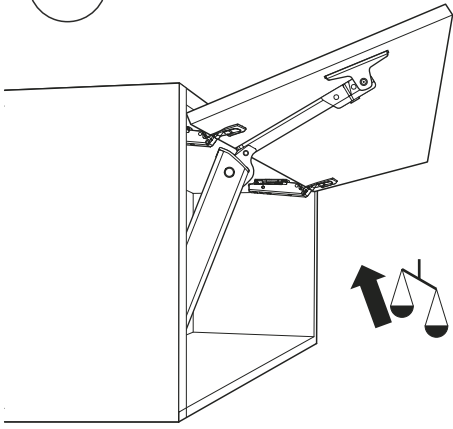

5

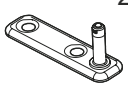
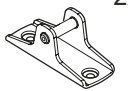

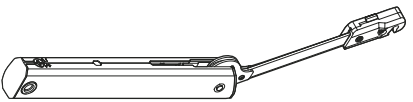
GO- 40/45/50/60	1x	1x	4x
GO- 80/90	2x	2x	8x
			
GO- 40/45/50/60			1x
GO- 80/90			2x