

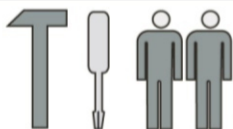











G-30



				 $\phi 4.0 \times 30 \text{mm}$					 $\phi 4.0 \times 16 \text{mm}$		 $\phi 4.0 \times 30 \text{mm}$
8	8	1	1	2	~20	4	2	2	4	2	8

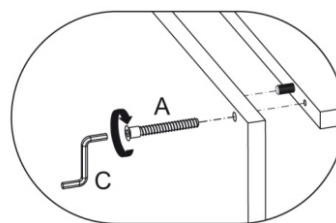
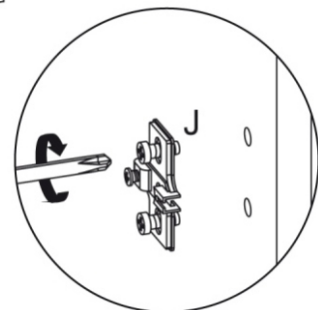
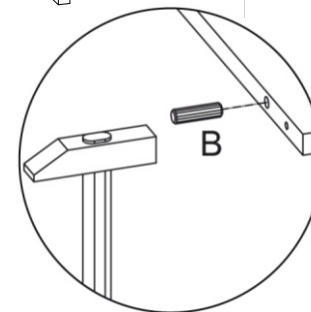
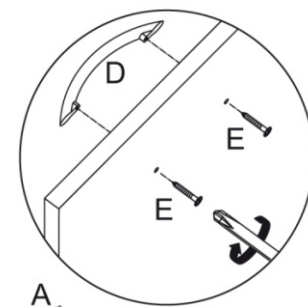
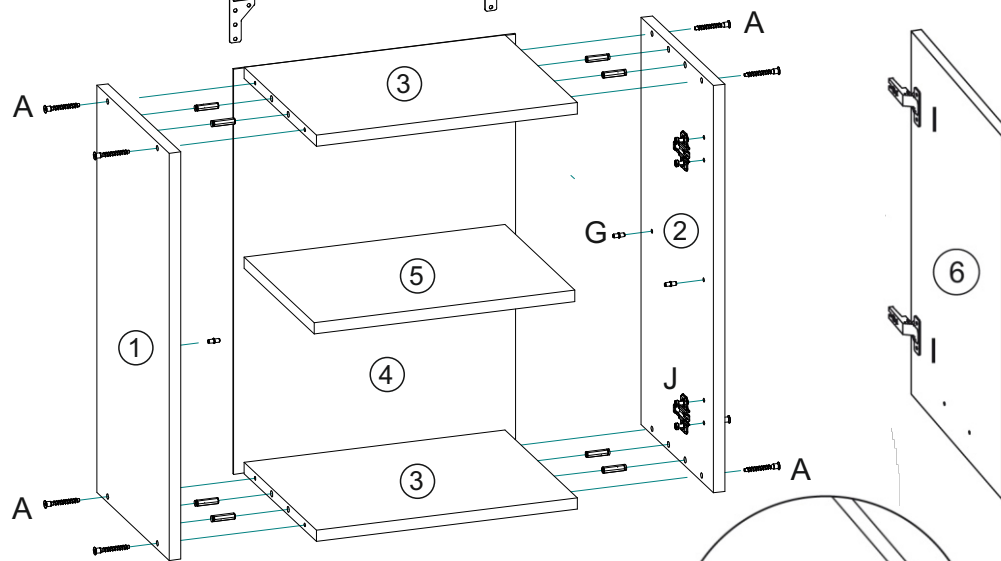
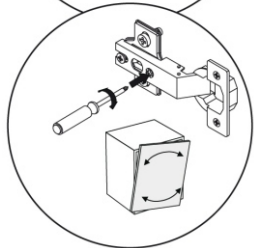
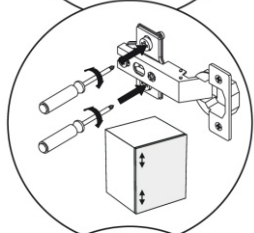
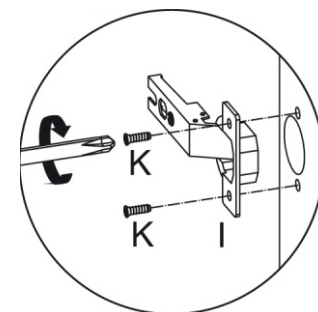
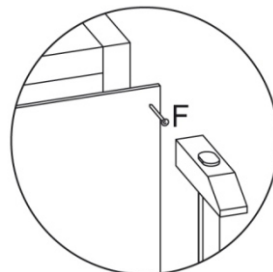
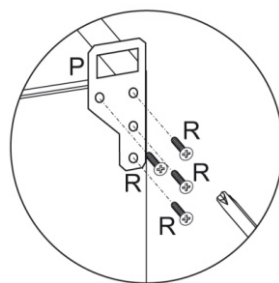
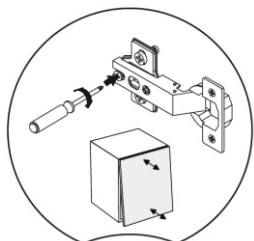

No	DŁUGOŚĆ LENGTH LÄNGE LONGUEUR	SZEROKOŚĆ WIDTH BREITE LARGEUR	GRUBOŚĆ THICKNESS STÄRKE GROSSEUR	ILOŚĆ QUANTITY ANZAHL QUANTITÉ
1	573	280	16	1
2	573	280	16	1
3	267	279	16	2
4	570	297	3	1
5	267	270	16	1
6	296	570	16	1