



# kuchnie **SIMPLY**

2026

Z dumą przedstawiamy Państwu nasze nowe dziecko: kuchnię **SIMPLY**. Łączy w sobie nowoczesne wzornictwo, jakość i przystępną cenę. Żeby było jeszcze bardziej **SIMPLY** można kupić pojedyncze szafki, ale także specjalnie zaprojektowane praktyczne zestawy. Krótki okres realizacji zamówienia sprawia, że kupowanie kuchni nigdy nie było tak **SIMPLY**.

## FRONTY

### TAFLA



plyta laminowana 16 mm



dąb evoke



kaszmir



biały



czarny

plyta MDF 18 mm akryl



biały połysk



szary połysk

## KORPUS

Korpusy wykonane z płyty laminowanej 16 mm, dostępne w dwóch kolorach.



biały

dąb evoke

dąb cremona

## BLATY

Blaty o grubości 38 mm dostępne w długościach: 40, 60, 80, 105, 120, 140, 160, 180, 200, 260 cm. Blaty do wysp: 123,6 x 94 cm



dąb evoke



dąb cremona



district dark



wapień crema

**LISTWA KĄTOWA**  
do łączenia blatów  
(w kolorze czarnym)



### TAFLA B

plyta MDF 19 mm akryl

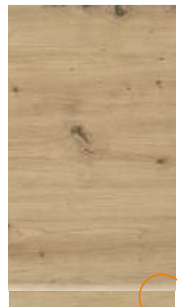

biały połysk

plyta laminowana 19 mm



dąb artisan



### TAFLA L

plyta laminowana 18 mm



dąb evoke

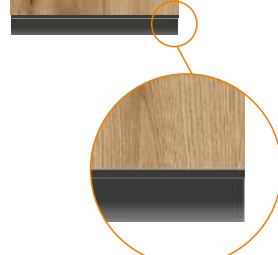

## RYFLA



plyta MDF 18 mm PCV



dąb cremona



dąb artisan



czarny



kaszmir



biały mat



witryna  
z czarną ramką aluminiową  
i szkłem ryflowanym

## OSWIETLENIE - TAŚMA LED

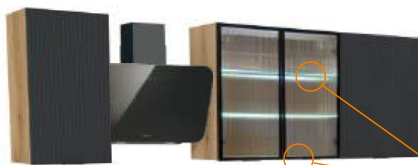

łatwe w montażu  
i dekoracyjne  
oświetlenie LED



## SZUFLADY

cienkie ścianki metalowe 2 mm,  
boki ścianki i prowadnice  
**HAFELE**  
z hamulcem



Super Slim

## BLENDY PIONOWA

służy do zakrycia widocznej  
przerznię przestrzeni pomiędzy szafką  
dolną a ścianą

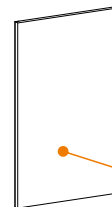

## BLENDY BOCZNA

Dostępne w kolorze frontów i korpusów, służą do przykrycia kończących boków szafek. Wymiary paneli: 720x200/74 (nie występuje w kolorze białym, dąb evoke i dąb cremona), 716x348/34 (nie występuje w kolorze białym, dąb evoke i dąb cremona).

## COKOŁY

Cokoły dostępne w dwóch wysokościach: 10, 15 cm.

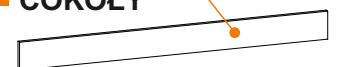

## ■ SZAFKI GÓRNE

Wymiary szafek, cokołów, podane w cm.

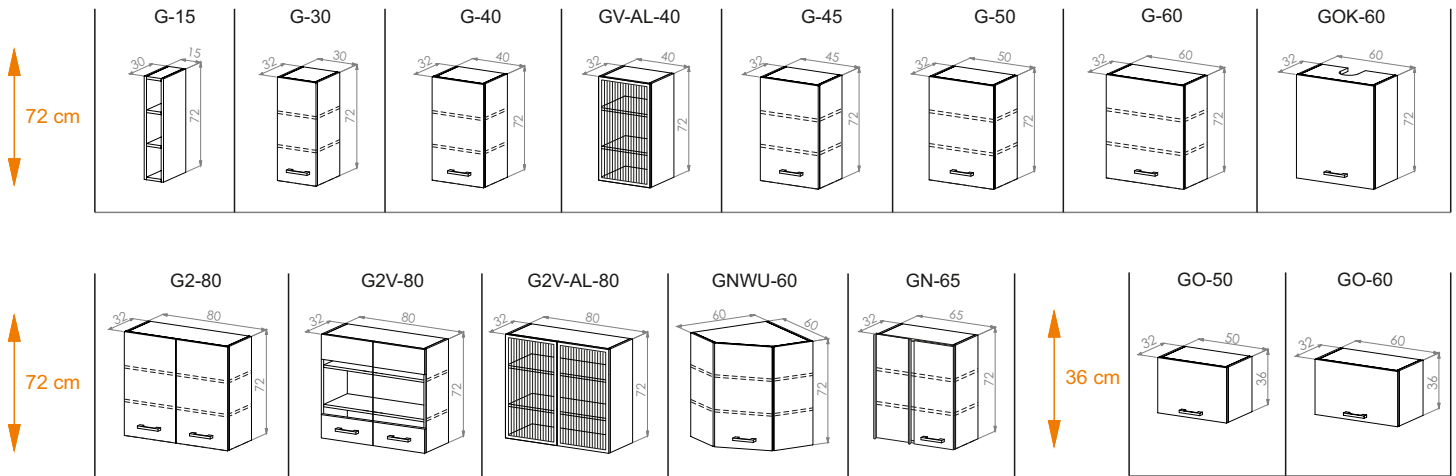

## ■ SZAFKI DOLNE

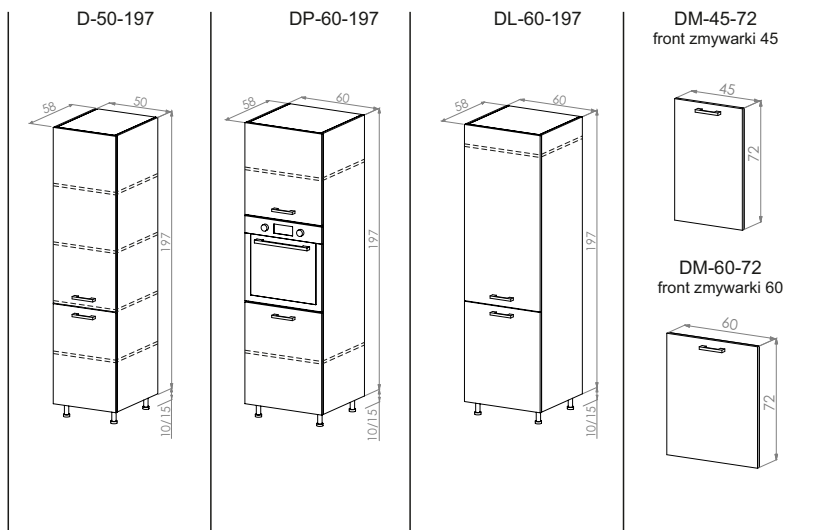
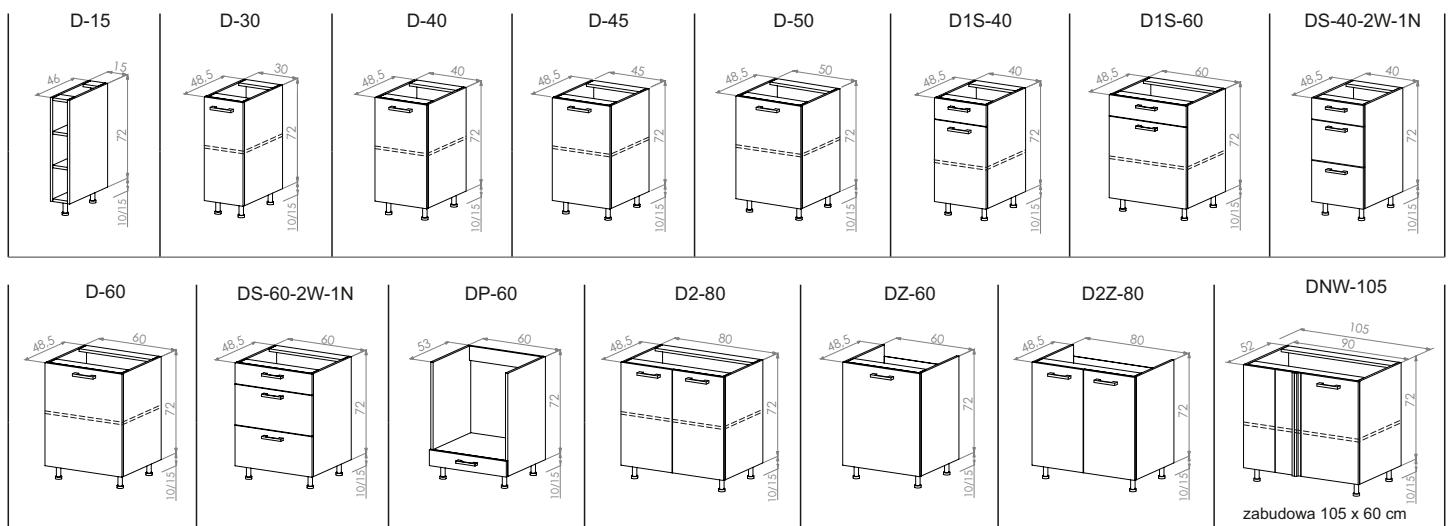

## ■ SZAFKA FUNKCYJNA

S/D-60-142

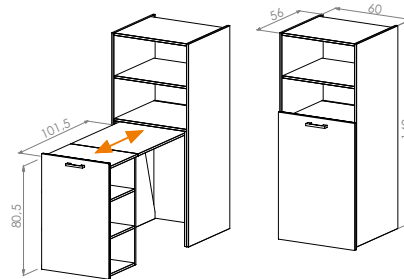

zeskanuj kod  
zobacz więcej



Świetne rozwiązanie do małych pomieszczeń. Wysuwany element szafki może służyć jako dodatkowy blat roboczy i miejsce do przechowywania lub stół czy biurko do pracy.

## ■ WYSPY

Przykładowe zestawy szafek.

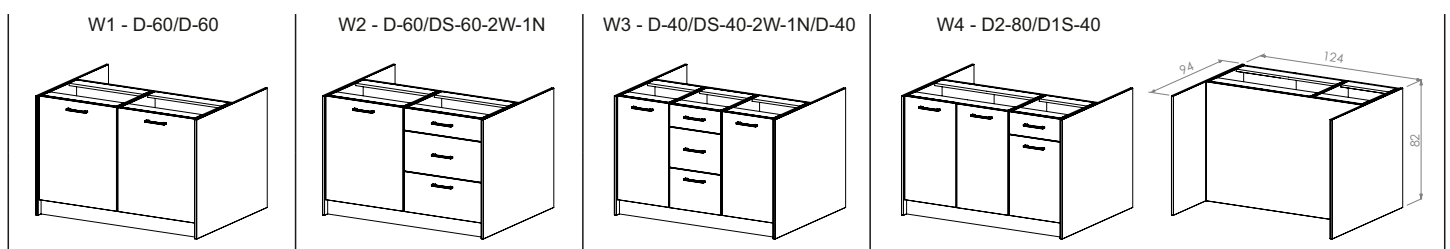

■ PRZYKŁADOWE ZESTAWY 170



**Z1**

korpus: biały  
front: TAFLA  
kaszmir  
blat: dąb evoke

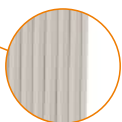
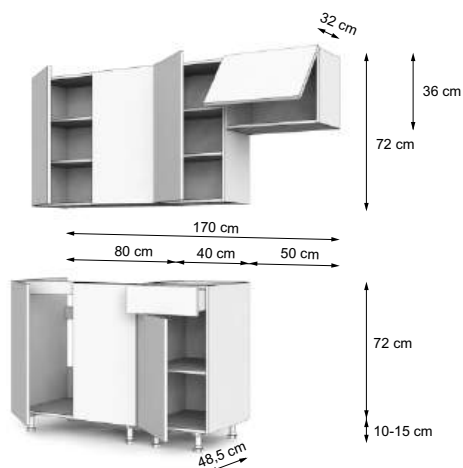

**Z2**

korpus: biały  
front: RYFLA kaszmir/  
TAFLA kaszmir  
blat: dąb evoke

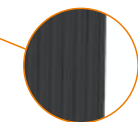

**Z9**

korpus: dąb evoke  
front: RYFLA czarny/  
TAFLA dąb evoke  
blat: district dark



**Z5**

korpus: dąb evoke  
front: TAFLA  
dąb evoke/czarny  
blat: district dark



**Z11**

korpus: biały/  
dąb evoke  
front: TAFLA B biały  
połysk/dąb artisan  
blat: district dark



**Z6**

korpus: dąb evoke  
front: TAFLA  
dąb evoke  
blat: dąb evoke



**Z12**

korpus: biały  
front: TAFLA B  
biały połysk  
blat: dąb evoke



**Z7**

korpus: dąb evoke  
front: TAFLA  
kaszmir/dąb evoke  
blat: district dark



**Z13**

korpus: dąb evoke  
front: TAFLA B  
biały połysk  
blat: dąb evoke

■ PRZYKŁADOWE ZESTAWY 170



**Z14**

korpus: dąb evoke  
front: RYFLA dąb  
artisan/TAFLA  
szary połysk  
blat: dąb evoke



**Z24**

korpus: dąb cremona  
front: TAFLA biały  
blat: dąb cremona



**Z15**

korpus: dąb evoke  
front: RYFLA dąb  
artisan/TAFLA  
biały połysk  
blat: district dark



**Z25**

korpus: dąb cremona  
front: TAFLA  
szary połysk  
blat: dąb cremona



**Z17**

korpus: dąb evoke  
front: TAFLA L  
dąb evoke  
blat: district dark



**Z26**

korpus: biały  
front: TAFLA kaszmir  
blat: wapień crema



**Z21**

korpus: biały  
front: RYFLA biały/  
TAFLA biały  
blat: district dark



**Z27**

korpus: dąb evoke  
front: RYFLA kaszmir/  
TAFLA dąb evoke  
blat: wapień crema



**Z22**

korpus: dąb evoke  
front: TAFLA  
biały/dąb evoke  
blat: district dark



■ PRZYKŁADOWE ZESTAWY 200



**Z1**

korpus: biały  
front: TAFLA  
kaszmir  
blat: dąb evoke

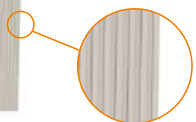
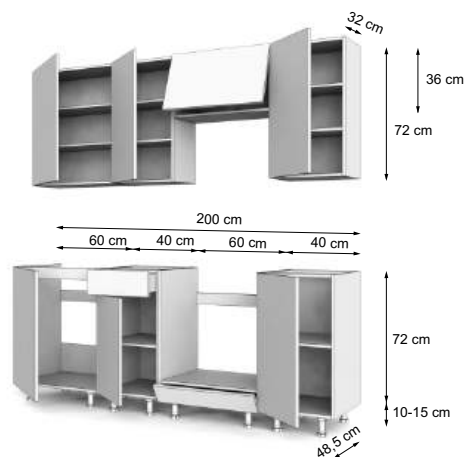

**Z2**

korpus: biały  
front: RYFLA kaszmir/  
TAFLA kaszmir  
blat: dąb evoke



**Z9**

korpus: dąb evoke  
front: RYFLA czarny/  
TAFLA dąb evoke  
blat: district dark



**Z5**

korpus: dąb evoke  
front: TAFLA  
dąb evoke/czarny  
blat: district dark



**Z11**

korpus: biały/  
dąb evoke  
front: TAFLA B biały  
połysk/dąb artisan  
blat: district dark



**Z6**

korpus: dąb evoke  
front: TAFLA  
dąb evoke  
blat: dąb evoke



**Z12**

korpus: biały  
front: TAFLA B  
biały połysk  
blat: dąb evoke



**Z7**

korpus: dąb evoke  
front: TAFLA  
kaszmir/dąb evoke  
blat: district dark



**Z13**

korpus: dąb evoke  
front: TAFLA B  
biały połysk  
blat: dąb evoke

■ PRZYKŁADOWE ZESTAWY 200



**Z14**

korpus: dąb evoke  
front: RYFLA dąb  
artisan/TAFLA  
szary połysk  
blat: dąb evoke



**Z24**

korpus: dąb cremona  
front: TAFLA biały  
blat: dąb cremona



**Z15**

korpus: dąb evoke  
front: RYFLA dąb  
artisan/TAFLA  
biały połysk  
blat: district dark



**Z25**

korpus: dąb cremona  
front: TAFLA  
szary połysk  
blat: dąb cremona



**Z17**

korpus: dąb evoke  
front: TAFLA L  
dąb evoke  
blat: district dark



**Z26**

korpus: biały  
front: TAFLA  
kaszmir  
blat: wapień crema



**Z21**

korpus: biały  
front: RYFLA biały/  
TAFLA biały  
blat: district dark



**Z27**

korpus: dąb evoke  
front: RYFLA kaszmir/  
TAFLA dąb evoke  
blat: wapień crema



**Z22**

korpus: dąb evoke  
front: TAFLA  
biały/dąb evoke  
blat: district dark



**PRZYKŁADOWE ZESTAWY 260**



**Z1**

korpus: biały  
front: TAFLA kaszmir  
blat: dąb evoke

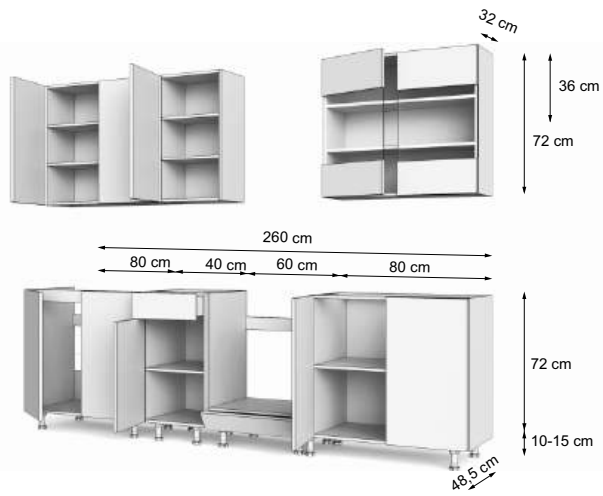

**Z2**

korpus: biały  
front: RYFLA kaszmir/  
TAFLA kaszmir  
blat: dąb evoke



**Z9**

korpus: dąb evoke  
front: RYFLA czarny/  
TAFLA dąb evoke  
blat: district dark



**Z5**

korpus: dąb evoke  
front: TAFLA  
dąb evoke/czarny  
blat: district dark



**Z11**

korpus: biały/  
dąb evoke  
front: TAFLA B biały  
połysk/dąb artisan  
blat: district dark



**Z6**

korpus: dąb evoke  
front: TAFLA  
dąb evoke  
blat: dąb evoke



**Z12**

korpus: biały  
front: TAFLA B  
biały połysk  
blat: dąb evoke



**Z7**

korpus: dąb evoke  
front: TAFLA  
kaszmir/dąb evoke  
blat: district dark



**Z13**

korpus: dąb evoke  
front: TAFLA B  
biały połysk  
blat: dąb evoke

■ PRZYKŁADOWE ZESTAWY 260



**Z14**

korpus: dąb evoke  
front: RYFLA dąb  
artisan/TAFLA  
szary połysk  
blat: dąb evoke



**Z24**

korpus: dąb cremona  
front: TAFLA biały  
blat: dąb cremona



**Z15**

korpus: dąb evoke  
front: RYFLA dąb  
artisan/TAFLA  
biały połysk  
blat: district dark



**Z25**

korpus: dąb cremona  
front: TAFLA  
szary połysk  
blat: dąb cremona



**Z17**

korpus: dąb evoke  
front: TAFLA L  
dąb evoke  
blat: district dark



**Z26**

korpus: biały  
front: TAFLA  
kaszmir  
blat: wapień crema



**Z21**

korpus: biały  
front: RYFLA biały/  
TAFLA biały  
blat: district dark



**Z27**

korpus: dąb evoke  
front: RYFLA kaszmir/  
TAFLA dąb evoke  
blat: wapień crema



**Z22**

korpus: dąb evoke  
front: TAFLA  
biały/dąb evoke  
blat: district dark



■ PRZYKŁADOWE ZESTAWY NAROŻNE

240 cm  
40 cm 60 cm 80 cm 60 cm

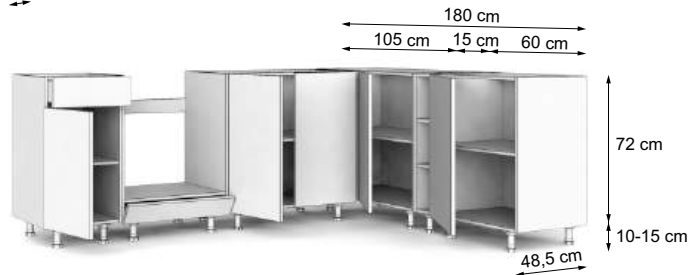

**Z1**

korpus: biały  
front: TAFLA  
kaszmir  
blat: dąb evoke



**Z2**

korpus: biały  
front: RYFLA kaszmi  
TAFLA kaszmir  
blat: dąb evoke



przykładowa opcja  
z witryną ze szkłem  
ryflowanym

**Z9**

korpus: dąb evoke  
front: RYFLA czarny/  
TAFLA dąb evoke  
blat: district dark



**Z5**

korpus: dąb evoke  
front: TAFLA  
dąb evoke/czarny  
blat: district dark



**Z11**

korpus: biały/  
dąb evoke  
front: TAFLA B biały  
połysk/dąb artisan  
blat: district dark



**Z6**

korpus: dąb evoke  
front: TAFLA  
dąb evoke  
blat: dąb evoke



**Z12**

korpus: biały  
front: TAFLA B  
biały połysk  
blat: dąb evoke



**Z7**

korpus: dąb evoke  
front: TAFLA  
kaszmir/dąb evoke  
blat: district dark



**Z13**

korpus: dąb evoke  
front: TAFLA B  
biały połysk  
blat: dąb evoke

■ PRZYKŁADOWE ZESTAWY NAROŻNE



**Z14**

korpus: dąb evoke  
front: RYFLA dąb  
artisan/TAFLA  
szary połysk  
blat: dąb evoke



**Z24**

korpus: dąb cremona  
front: TAFLA biały  
blat: dąb cremona



**Z15**

korpus: dąb evoke  
front: RYFLA dąb  
artisan/TAFLA  
biały połysk  
blat: district dark



**Z25**

korpus: dąb cremona  
front: TAFLA  
szary połysk  
blat: dąb cremona



**Z17**

korpus: dąb evoke  
front: TAFLA L  
dąb evoke  
blat: district dark



**Z26**

korpus: biały  
front: TAFLA  
kaszmir  
blat: wapień crema



**Z21**

korpus: biały  
front: RYFLA biały/  
TAFLA biały  
blat: district dark



**Z27**

korpus: dąb evoke  
front: RYFLA kaszmir/  
TAFLA dąb evoke  
blat: wapień crema



**Z22**

korpus: dąb evoke  
front: TAFLA  
biały/dąb evoke  
blat: district dark



## ■ DEDYKOWANY SPRZĘT AGD I WYPOSAŻENIE SZAFEK



CARGO - szerokość 30 i 40 cm



CORNER



OCIEKARKI - do wyboru ociekarka dwupozioma lub jednopoziomowa w dwóch szer. 60 cm i 80 cm

## ■ OKAPY



Okap naścienny **SPOT**  
wykończenie: stal nierdzewna  
szerokość: 60 cm  
3 stopniowa regulacja mocy  
oświetlenie LED  
pracuje w trybie:  
pochłaniacz, wyciąg



Okap przyścienny **LIXA**  
wykończenie: czarne szkło  
szerokość: 60 cm  
3 stopniowa regulacja mocy  
oświetlenie LED  
pracuje w trybie:  
pochłaniacz, wyciąg



Okap do zabudowy **ERA**  
wykończenie: stal nierdzewna  
szerokość: 60 cm  
oświetlenie LED  
mechaniczna regulacja mocy  
pracuje w trybie:  
pochłaniacz, wyciąg

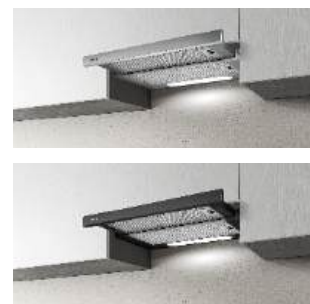

Okap podszafrkowy **ELITE**  
wykończenie:  
stal nierdzewna, czarny  
szerokość: 60 cm  
oświetlenie LED  
mechaniczna regulacja mocy  
pracuje w trybie:  
pochłaniacz, wyciąg

## ■ ZLEWY, BATERIE



Zlewozmywak  
dwukomorowy nakładany  
**PRIMAL**  
materiał: inox  
wymiary: 800 x 600 mm



Zlewozmywak  
jednokomorowy nakładany  
**PRIMAL**  
materiał: inox  
wymiary: 800 x 600 mm



Zlewozmywak wpuszczany  
**START**  
materiał: inox  
wymiary: 615 x 500 mm



Bateria **KARINA**  
materiał: chrom



Zestaw: zlewozmywak wpuszczany **NESS**  
materiał: granit czarny wymiary: 590 x 440 mm  
bateria **KATI** materiał: granit czarny

## ■ KOSZE NA ODPADY



kosz automat (13l)

sesamo 2 (2x8l)

## ■ WKŁADY DO SZUFLAD



60 cm

30 cm

Gazetka ma charakter poglądowy. Zdjęcia i rysunki mogą się nieznacznie różnić od rzeczywistych. Ze względu na technologię druku prezentowane kolory mogą odbiegać od rzeczywistych kolorów. Producent może wprowadzić zmiany kolorów, wzornictwa, wymiarów i funkcji prezentowanych wyrobów.



**FABRYKA MEBLI RAWA Sp. z o.o.**  
ul. Księża Domki 41  
96-200 Rawa Mazowiecka  
[www.rawafm.pl](http://www.rawafm.pl)